



Elementy gumowo - metalowe
Rubber - metal parts

FIAT

Opis / description

SHOCK ABSORBER MOUNTING
MOCOWANIE AMORTYZATORA

Zastosowanie / application

FIORINO, LINEA (323), GRANDE PUNTO (199)

O.E.

51890880

| MM Long | MM Short |
|--------------|----------|
| 030607010601 | 010601 |



Opis / description

SHOCK ABSORBER MOUNTING
MOCOWANIE AMORTYZATORA

Zastosowanie / application

FIORINO, LINEA (323), GRANDE PUNTO (199)

O.E.

51890881

| MM Long | MM Short |
|--------------|----------|
| 030607010602 | 010602 |



Opis / description

ENGINE MOUNTING
PODUSZKA SILNIKA

Zastosowanie / application

DOBLO 1.6 MJTD

O.E.

51815197

| MM Long | MM Short |
|--------------|----------|
| 030607010603 | 010603 |



Opis / description

ENGINE MOUNTING
PODUSZKA SILNIKA

Zastosowanie / application

GRANDE PUNTO (199), LINEA (323), ALFA MITO (955)

O.E.

51813198

| MM Long | MM Short |
|--------------|----------|
| 030607010604 | 010604 |



FIAT

Opis / description

ENGINE MOUNTING FRONT
 PODUSZKASILNIKA PRZÓD

Zastosowanie / application

DUCATO 2.2 JTD 06--->

O.E.

1343242080

| MM Long | MM Short |
|--------------|----------|
| 030607010605 | 010605 |



Opis / description

ENGINE MOUNTING
 PODUSZKA SILNIKA

Zastosowanie / application

DUCATO III 2.3JTD 06

O.E.

1363376080

| MM Long | MM Short |
|--------------|----------|
| 030607010606 | 010606 |



Opis / description

GEARBOX MOUNTING
 PODUSZKA SKRZYNI BIEGÓW

Zastosowanie / application

DUCATO III 3.0JTD 06 >

O.E.

1352888080

| MM Long | MM Short |
|--------------|----------|
| 030607010607 | 010607 |



Opis / description

ENGINE MOUNTING
 PODUSZKA SILNIKA

Zastosowanie / application

DUCATO 3.0JTD 160HP

O.E.

1358088080

| MM Long | MM Short |
|--------------|----------|
| 030607010608 | 010608 |



FIAT

Opis / description

SHOCK BOTTOM PLATE
MISKA AMORTYZATORA

Zastosowanie / application

DUCATO 2006-

O.E.

50706256

| MM Long | MM Short |
|--------------|----------|
| 030607010609 | 010609 |



Opis / description

SUSPENSION RUBBER BUFFER
ODBOJNIK AMORTYZATORA

Zastosowanie / application

DUCATO Q12-Q14-Q16

O.E.

50706737

| MM Long | MM Short |
|--------------|----------|
| 030607010610 | 010610 |



Opis / description

SUSPENSION RUBBER BUFFER
ODBOJNIK AMORTYZATORA

Zastosowanie / application

DUCATO III 2,2/2,3/3,0JTD

O.E.

50707856

| MM Long | MM Short |
|--------------|----------|
| 030607010611 | 010611 |



Opis / description

SUSPENSION RUBBER BUFFER
ODBOJNIK AMORTYZATORA

Zastosowanie / application

DUCATO III2.2HDI - 3.0HDI

O.E.

50705220

| MM Long | MM Short |
|--------------|----------|
| 030607010612 | 010612 |



FIAT

Opis / description

SUSPENSION RUBBER BUFFER
ODBOJNIK TYLNY

Zastosowanie / application

DUCATO III 2.2HDI - 3.0HDI

O.E.

1355891080

| MM Long | MM Short |
|--------------|----------|
| 030607010613 | 010613 |

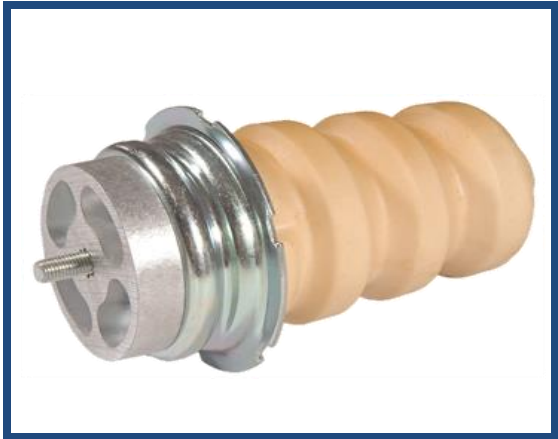

Opis / description

SHOCK ABSORBER PROTECTION KIT
ZESTAW OCHRONNY AMORTYZATORA

Zastosowanie / application

FIAT DUCATO

O.E.

1340928080

| MM Long | MM Short |
|--------------|----------|
| 030607010614 | 010614 |



Opis / description

SUSPENSION REBOUND RUBBER BUFFER
ODBOJNIK RESORA

Zastosowanie / application

FIAT DUCATO III 2.2-2.3-3.0 / JTD

O.E.

1351266080

| MM Long | MM Short |
|--------------|----------|
| 030607010615 | 010615 |



Opis / description

SHOCK ABSORBER MOUNTING
MOCOWANIE AMORTYZATORA

Zastosowanie / application

FIAT GRANDE PUNTO

O.E.

51813225

| MM Long | MM Short |
|--------------|----------|
| 030607010616 | 010616 |



FIAT

Opis / description

SHOCK ABSORBER MOUNTING
MOCOWANIE AMORTYZATORA

Zastosowanie / application

FIAT GRANDE PUNTO

O.E.

55701902

| MM Long | MM Short |
|--------------|----------|
| 030607010617 | 010617 |



Opis / description

SHOCK ABSORBER MOUNTING
MOCOWANIE AMORTYZATORA

Zastosowanie / application

FIAT GRANDE PUNTO

O.E.

55701901

| MM Long | MM Short |
|--------------|----------|
| 030607010618 | 010618 |

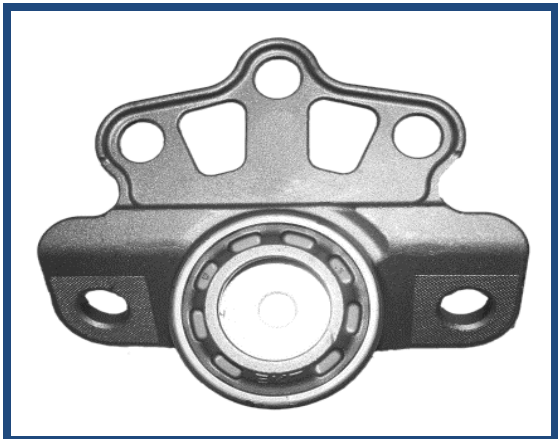

Opis / description

SHOCK ABSORBER MOUNTING
PODUSZKA AMORTYZATORA

Zastosowanie / application

FIAT LINEA, FIAT GRANDE PUNTO/EVO

O.E.

51761830

| MM Long | MM Short |
|--------------|----------|
| 030607010619 | 010619 |



Opis / description

TRANSMISSION MOUNTING
PODUSZKA SKRZYNI BIEGÓW

Zastosowanie / application

FIAT GRANDE PUNTO, FIAT LINEA

O.E.

55700439

| MM Long | MM Short |
|--------------|----------|
| 030607010620 | 010620 |

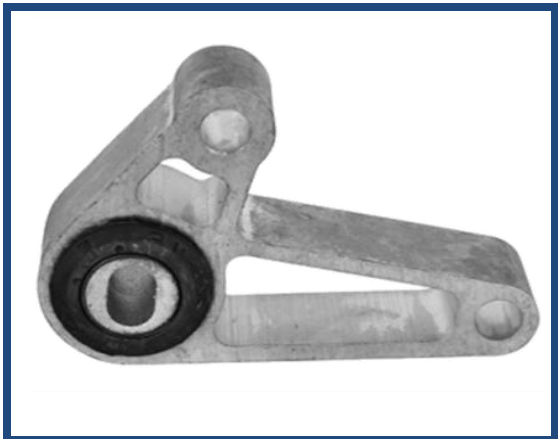

FIAT

Opis / description

ENGINE MOUNTING

PODUSZKA SILNIKA

Zastosowanie / application

FIAT GRANDE PUNTO/EVO 1.4 16V T-Jet 120HP -155HP

O.E.

51794078

| MM Long | MM Short |
|--------------|----------|
| 030607010621 | 010621 |



Opis / description

ENGINE MOUNTING

PODUSZKA SILNIKA

Zastosowanie / application

FIAT FIORINO Kamyonet/SW (225) - 1.3 D Multijet

FIAT QUBO (225) - 1.3 D Multijet

O.E.

51810285

| MM Long | MM Short |
|--------------|----------|
| 030607010622 | 010622 |



Opis / description

TRANSMISSION SIDE MOUNTING

PODUSZKA OD STRONY SKRZYNI BIEGÓW

Zastosowanie / application

FIAT DOBLO Kombi (152, 263) - 1.3 D Multijet 02.10

FIAT LINEA (323) - 1.3 D Multijet 06.07-

O.E.

51813603

| MM Long | MM Short |
|--------------|----------|
| 030607010623 | 010623 |



Opis / description

TRANSMISSION SIDE MOUNTING

PODUSZKA OD STRONY SKRZYNI BIEGÓW

Zastosowanie / application

FIAT Fiorino 1.4 16 V, CC 1.4 CMBBZ Linea 1.4,

FIAT QUBO1.4-1.3D Multijet-1.4 t-jet

O.E.

51761609

| MM Long | MM Short |
|--------------|----------|
| 030607010624 | 010624 |



FIAT

Opis / description

ENGINE MOUNTING
 PODUSZKA SILNIKA

Zastosowanie / application

FIAT Fiorino 1.4 , Linea 1.4, QUBO 1.4
 PEUGEOT Bipper 1.4, CITROEN – Nemo 1.4,

O.E.

51821084

| MM Long | MM Short |
|--------------|----------|
| 030607010625 | 010625 |

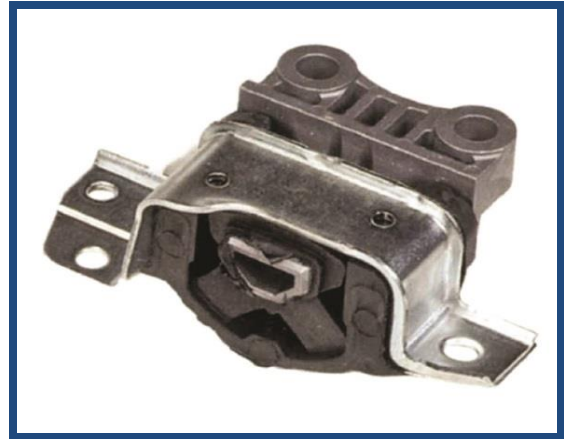

Opis / description

ENGINE MOUNTING
 PODUSZKA SILNIKA

Zastosowanie / application

FIAT LINEA, FIORINO 1.3 90 PS-1.6 105PS MJTD

O.E.

51799110

| MM Long | MM Short |
|--------------|----------|
| 030607010626 | 010626 |



Opis / description

ENGINE MOUNTING
 PODUSZKA SILNIKA

Zastosowanie / application

FIAT Fiorino, Qubo

O.E.

51855484

| MM Long | MM Short |
|--------------|----------|
| 030607010627 | 010627 |



Opis / description

ENGINE MOUNTING
 PODUSZKA SILNIKA

Zastosowanie / application

FIAT FIORINO 1.3 D MULTIJET, FIAT QUBO 1.3 -

O.E.

51805431

| MM Long | MM Short |
|--------------|----------|
| 030607010628 | 010628 |



FIAT

Opis / description

SUSPENTION MOUNTING REAR BIG
ODBOJNIK TYLNY DUŻY

Zastosowanie / application

FIAT FIORINO, FIAT QUBO, PEUGEOT BIPPER, NEMO

O.E.

51805787

| MM Long | MM Short |
|--------------|----------|
| 030607010630 | 010630 |



Opis / description

SUSPENTION MOUNTING REAR SMALL
ODBOJNIK TYLNY MAŁY

Zastosowanie / application

FIAT FIORINO, QUBO, PEUGEOT BIPPER, NEMO

O.E.

51804746

| MM Long | MM Short |
|--------------|----------|
| 030607010631 | 010631 |



Opis / description

TRANSMISSION MOUNTING
PODUSZKA SKRZYNI BIEGÓW

Zastosowanie / application

FIAT Ducato, PEUGEOT Boxer, CITROEN Jumper

O.E.

1352887080

| MM Long | MM Short |
|--------------|----------|
| 030607010632 | 010632 |

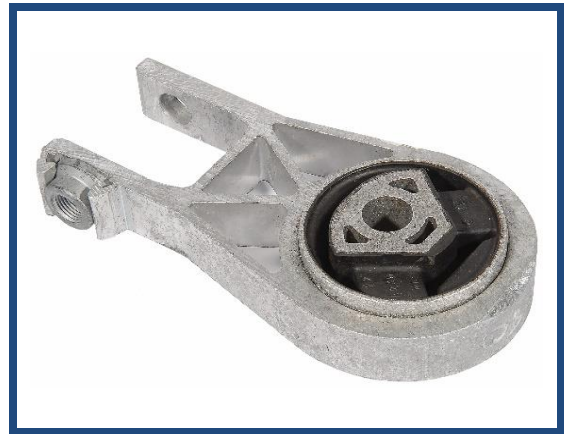

Opis / description

ENGINE MOUNTING
PODUSZKA SILNIKA

Zastosowanie / application

FIAT Ducato III 2.2 JTD - 2.3JTD 06->, Boxer III 2.2 JTD - 2.3JTD 06->, Jumper III 2.2 JTD - 2.3JTD 06->

O.E.

1346984080

| MM Long | MM Short |
|--------------|----------|
| 030607010634 | 010634 |



FIAT

Opis / description

ENGINE MOUNTING
 PODUSZKA SILNIKA

Zastosowanie / application

FIAT DUCATO 3.0JTD 160HP

O.E.

1358696080

| MM Long | MM Short |
|--------------|----------|
| 030607010636 | 010636 |



Opis / description

ENGINE MOUNTING
 PODUSZKA SILNIKA

Zastosowanie / application

FIAT DOBLO, PALIO, ALBEA, SIENA 1.9D - 1.9JTD

O.E.

46759568

| MM Long | MM Short |
|--------------|----------|
| 030607010637 | 010637 |

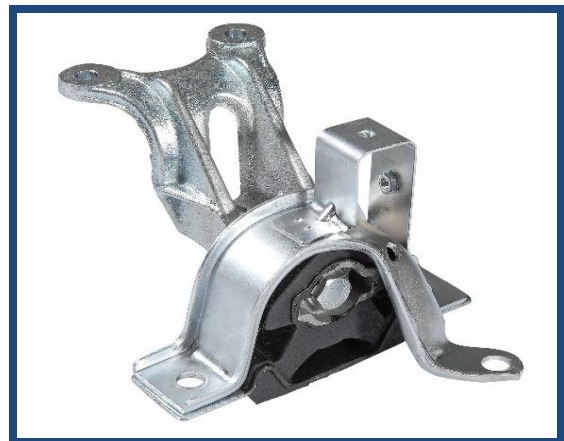

Opis / description

ENGINE MOUNTING
 PODUSZKA SILNIKA

Zastosowanie / application

FIAT DOBLO, PALIO, ALBEA, SIENA 1.3MJTD

O.E.

51718928

| MM Long | MM Short |
|--------------|----------|
| 030607010638 | 010638 |

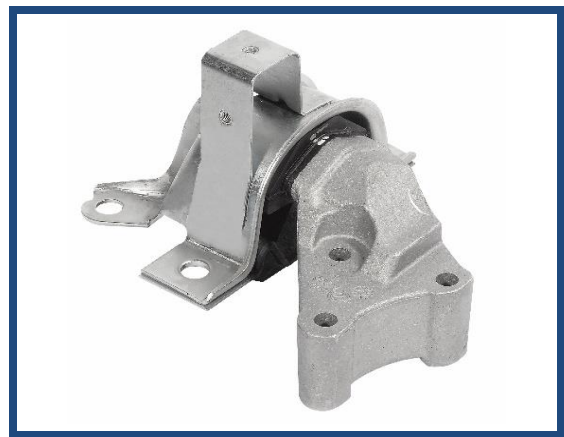

Opis / description

TRANSMISSION MOUNTING
 PODUSZKA SKRZYNI BIEGÓW

Zastosowanie / application

FIAT DOBLO, PALIO, ALBEA, SIENA 1.3JTD-1.9D-1.9JTD

O.E.

46759737

| MM Long | MM Short |
|--------------|----------|
| 030607010639 | 010639 |



FIAT

Opis / description

TRANSMISSION MOUNTING
 PODUSZKA SKRZYNI BIEGÓW

Zastosowanie / application

FIAT DOBLO, PALIO, ALBEA, SIENA 1.3 m JET

O.E.

51731216

| MM Long | MM Short |
|--------------|----------|
| 030607010640 | 010640 |



Opis / description

ENGINE MOUNTING
 PODUSZKA SILNIKA

Zastosowanie / application

FIAT GRANDE PUNTO 1.2 8V 65 KM, 1.4 8V 77 KM, 16V 95 KM

O.E.

55700431

| MM Long | MM Short |
|--------------|----------|
| 030607010641 | 010641 |



Opis / description

ENGINE MOUNTING
 PODUSZKA SILNIKA

Zastosowanie / application

FIAT DOBLO 1.2 01/003> KW48 PS66

O.E.

46767475

| MM Long | MM Short |
|--------------|----------|
| 030607010642 | 010642 |



Opis / description

ENGINE MOUNTING
 PODUSZKA SILNIKA

Zastosowanie / application

FIAT Doblo 1.6

O.E.

46820471

| MM Long | MM Short |
|--------------|----------|
| 030607010643 | 010643 |



FIAT

Opis / description

ENGINE MOUNTING
 PODUSZKA SILNIKA

Zastosowanie / application

FIAT Doblo 1.4 8V 05

O.E.

51762065

| MM Long | MM Short |
|--------------|----------|
| 030607010644 | 010644 |

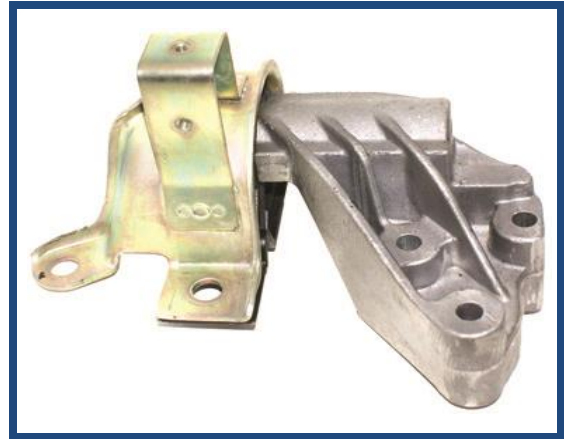

Opis / description

ENGINE MOUNTING
 PODUSZKA SILNIKA

Zastosowanie / application

FIAT FIORINO 1.3; 1.4 PPC 514 CC 1.4 PIPOWER; QUBO 1.4; LINEA 1.3 JTD, 1.4; DOBLO 1.4 10.09->02.10

O.E.

51813606

| MM Long | MM Short |
|--------------|----------|
| 030607010645 | 010645 |



Opis / description

ENGINE MOUNTING
 PODUSZKA SILNIKA

Zastosowanie / application

FIAT FIORINO; QUBO 02.08-

O.E.

51855515

| MM Long | MM Short |
|--------------|----------|
| 030607010646 | 010646 |



Opis / description

TRANSMISSION MOUNT
 PODUSZKA SILNIKA

Zastosowanie / application

FIAT FIORINO 1.4 8V; LINEA 1.4 8V 06.07-

O.E.

51813607

| MM Long | MM Short |
|--------------|----------|
| 030607010647 | 010647 |



FIAT

Opis / description

TRANSMISSION MOUNT
 PODUSZKA SILNIKA

Zastosowanie / application

FIAT - FIORINO 1.3 JTD EURO 5 09.08-

O.E.

51855676

| MM Long | MM Short |
|--------------|----------|
| 030607010648 | 010648 |



Opis / description

TRANSMISSION MOUNT
 PODUSZKA SILNIKA

Zastosowanie / application

FIAT LINEA 1.4 T-JET 09.07-

O.E.

51813029

| MM Long | MM Short |
|--------------|----------|
| 030607010649 | 010649 |



Opis / description

SHOCK ABSORB. MOUNT
 MOCOWANIE AMORTYZATORA

Zastosowanie / application

FIAT DUCATO; PEUGEOT BOXER; CITROEN JUMPER 04.02-

O.E.

1307241080; 1323165080

| MM Long | MM Short |
|--------------|----------|
| 030607010650 | 010650 |

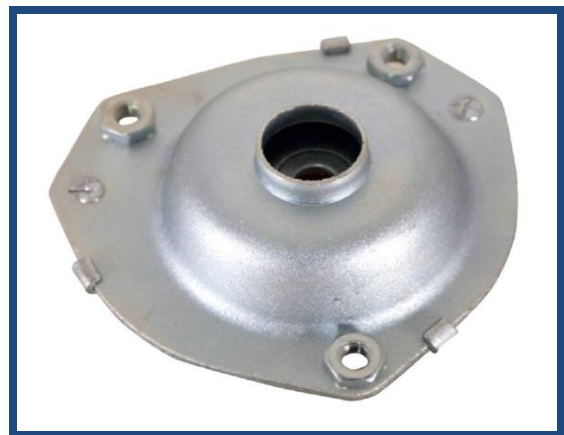

Opis / description

SHOCK ABSORB. MOUNT
 MOCOWANIE AMORTYZATORA

Zastosowanie / application

FIAT DUCATO; PEUGEOT BOXER; CITROEN JUMPER 04.02-

O.E.

1307242080; 1323166080

| MM Long | MM Short |
|--------------|----------|
| 030607010651 | 010651 |



FIAT

Opis / description

SHOCK ABSORB. MOUNT

MOCOWANIE AMORTYZATORA

Zastosowanie / application

FIAT DUCATO; PEUGEOT BOXER; CITROEN JUMPER 09.00-04.02-

O.E.

1338762080; 1339629080; 1345897080; 1350789080

MM Long

MM Short

030607010652

010652



Opis / description

SHOCK ABSORB. MOUNT

MOCOWANIE AMORTYZATORA

Zastosowanie / application

FIAT DUCATO; PEUGEOT BOXER; CITROEN JUMPER 09.00-04.02-04.06-06.11-

O.E.

1339628080; 1345896080; 1338761080; 1350788080

MM Long

MM Short

030607010653

010653



Opis / description

TRANSMISSION MOUNT

PODUSZKA SILNIKA

Zastosowanie / application

FIAT DUCATO; PEUGEOT BOXER; CITROEN JUMPER 07.06-

O.E.

1361494080

MM Long

MM Short

030607010654

010654



Opis / description

ENGINE MOUNTING

PODUSZKA SILNIKA

Zastosowanie / application

FIAT DUCATO; PEUGEOT BOXER; CITROEN JUMPER 2002

O.E.

1335124080

MM Long

MM Short

030607010655

010655



FIAT

Opis / description

ENGINE MOUNTING
 PODUSZKA SILNIKA

Zastosowanie / application

FIAT DUCATO; PEUGEOT BOXER; CITROEN JUMPER 04.02-

O.E.

1335125080

| MM Long | MM Short |
|--------------|----------|
| 030607010656 | 010656 |

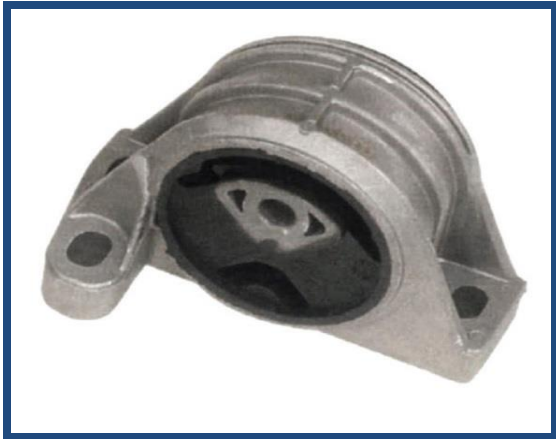

Opis / description

ENGINE MOUNTING
 PODUSZKA SILNIKA

Zastosowanie / application

FIAT DUCATO; PEUGEOT BOXER; CITROEN JUMPER 04.02-

O.E.

1335127080

| MM Long | MM Short |
|--------------|----------|
| 030607010657 | 010657 |

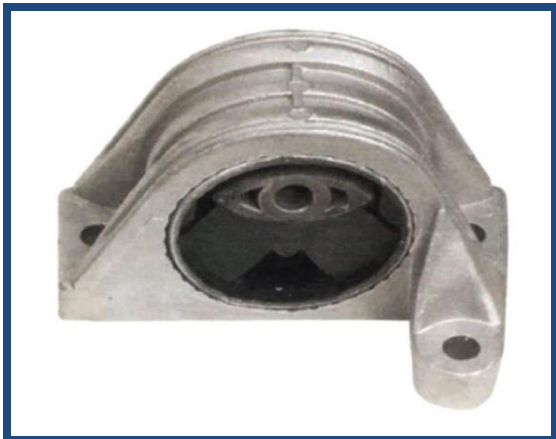

Opis / description

ENGINE MOUNTING
 PODUSZKA SILNIKA

Zastosowanie / application

FIAT DUCATO 2.5 TD - 2.8 TD - 94-02
 PEUGEOT BOXER 2.5 TD 2.8 TD - 94-02

O.E.

1307907080

| MM Long | MM Short |
|--------------|----------|
| 030607010658 | 010658 |

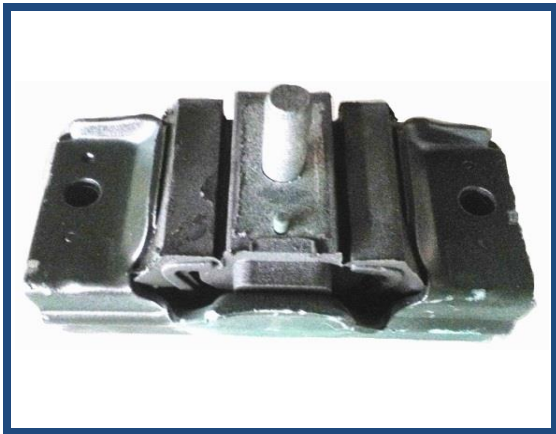

Opis / description

ENGINE MOUNTING
 PODUSZKA SILNIKA

Zastosowanie / application

FIAT DUCATO, PEUGEOT BOXER, CITROEN JUMPER 2.5 TD - 2.8 TD - 94-03-

O.E.

1307908080

| MM Long | MM Short |
|--------------|----------|
| 030607010659 | 010659 |



FIAT

Opis / description

COTROL ARM BUSHING

TULEJA WAHACZA

Zastosowanie / application

FIAT DUCATO; PEUGEOT BOXER; CITROEN JUMPER 04.06-

O.E.

50705198

| MM Long | MM Short |
|--------------|----------|
| 030607010660 | 010660 |



Opis / description

COTROL ARM BUSHING

TULEJA WAHACZA

Zastosowanie / application

FIAT DUCATO; PEUGEOT BOXER; CITROEN JUMPER 04.06-

O.E.

50705197

| MM Long | MM Short |
|--------------|----------|
| 030607010661 | 010661 |



Opis / description

SHOCK ABSORB. MOUNT

MOCOWANIE AMORTYZATORA

Zastosowanie / application

FIAT DOBLO, PALIO, ALBEA, SIENA 05.97-02.02-<

O.E.

82491441; 46760674

| MM Long | MM Short |
|--------------|----------|
| 030607010662 | 010662 |



Opis / description

SHOCK ABSORB. MOUNT

MOCOWANIE AMORTYZATORA

Zastosowanie / application

FIAT PALIO, SIENA, ALBEA 02.02-05.12-

O.E.

46464273

| MM Long | MM Short |
|--------------|----------|
| 030607010663 | 010663 |



FIAT

Opis / description

TRANSMISSION MOUNT
 PODUSZKA SILNIKA

Zastosowanie / application

FIAT PALIO, ALBEA, SIENA 1996

O.E.

46843629

| MM Long | MM Short |
|--------------|----------|
| 030607010664 | 010664 |



Opis / description

TRANSMISSION MOUNT
 PODUSZKA SILNIKA

Zastosowanie / application

FIAT PALIO, ALBEA, SIENA 1996

O.E.

51709313

| MM Long | MM Short |
|--------------|----------|
| 030607010665 | 010665 |



Opis / description

ENGINE MOUNTING
 PODUSZKA SILNIKA

Zastosowanie / application

FIAT GRANDE PUNTO 2006

O.E.

55700435

| MM Long | MM Short |
|--------------|----------|
| 030607010666 | 010666 |



Opis / description

ENGINE MOUNTING
 PODUSZKA SILNIKA

Zastosowanie / application

FIAT GRANDE PUNTO 2006

O.E.

55702833

| MM Long | MM Short |
|--------------|----------|
| 030607010667 | 010667 |

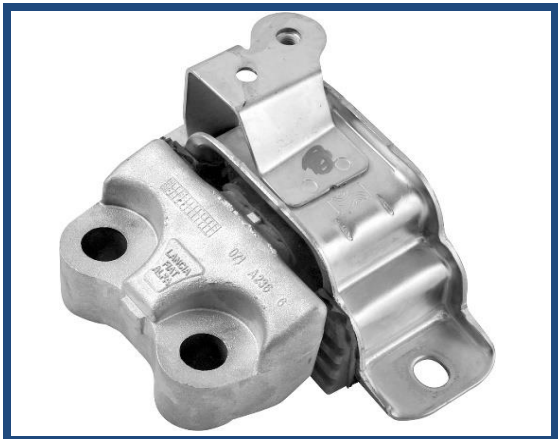

FIAT

Opis / description

ENGINE MOUNTING
 PODUSZKA SILNIKA

Zastosowanie / application

FIAT GRANDE PUNTO 2006

O.E.

55703651; 55700433

| MM Long | MM Short |
|--------------|----------|
| 030607010668 | 010668 |

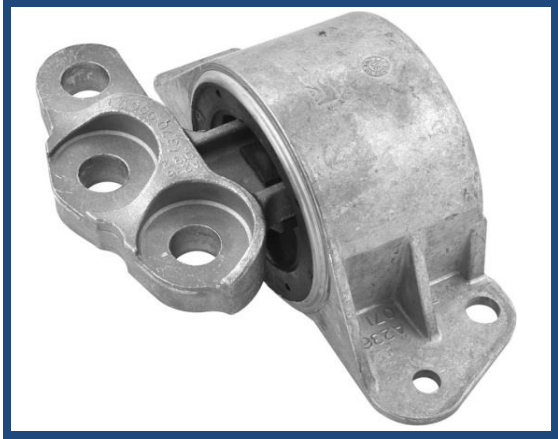

Opis / description

ENGINE MOUNTING
 PODUSZKA SILNIKA

Zastosowanie / application

FIAT GRANDE PUNTO 2006

O.E.

55700434

| MM Long | MM Short |
|--------------|----------|
| 030607010669 | 010669 |



Opis / description

HUNGER MOUNTING
 PODUSZKA SILNIKA

Zastosowanie / application

FIAT GRANDE PUNTO 2006

O.E.

55700440

| MM Long | MM Short |
|--------------|----------|
| 030607010670 | 010670 |



Opis / description

ENGINE MOUNTING
 PODUSZKA SILNIKA

Zastosowanie / application

FIAT GRANDE PUNTO 2006

O.E.

55700441

| MM Long | MM Short |
|--------------|----------|
| 030607010671 | 010671 |



FIAT

Opis / description

HUNGER MOUNTING
 PODUSZKA SILNIKA

Zastosowanie / application

FIAT GRANDE PUNTO 2006

O.E.

55702836

| MM Long | MM Short |
|--------------|----------|
| 030607010672 | 010672 |



Opis / description

ENGINE MOUNTING
 PODUSZKA SILNIKA

Zastosowanie / application

FIAT NEW DOBLO 2009

O.E.

51815759

| MM Long | MM Short |
|--------------|----------|
| 030607010673 | 010673 |



Opis / description

ENGINE MOUNTING
 PODUSZKA SILNIKA

Zastosowanie / application

FIAT DOBLO 1.4 2009

O.E.

51849522

| MM Long | MM Short |
|--------------|----------|
| 030607010674 | 010674 |



Opis / description

ENGINE MOUNTING
 PODUSZKA SILNIKA

Zastosowanie / application

FIAT DOBLO 1.3 MJTD 90HP CF4 2009

O.E.

51837816

| MM Long | MM Short |
|--------------|----------|
| 030607010675 | 010675 |



FIAT

Opis / description

ENGINE MOUNTING
 PODUSZKA SILNIKA

Zastosowanie / application

FIAT PALIO, SIENA, ALBEA 02.02-05.12-<

O.E.

46833123

| MM Long | MM Short |
|--------------|----------|
| 030607010676 | 010676 |



Opis / description

ENGINE MOUNTING
 PODUSZKA SILNIKA

Zastosowanie / application

FIAT PALIO, SIENA, ALBEA 1.2 - 1.4 03-97-02.02-06.11-<

O.E.

46523938

| MM Long | MM Short |
|--------------|----------|
| 030607010677 | 010677 |



Opis / description

TRANSMISSION MOUNT
 PODUSZKA SILNIKA

Zastosowanie / application

FIAT PALIO, SIENA, ALBEA 1.2 - 1.6 SPEEDGEAR 04.02-04.12-<

O.E.

46808873

| MM Long | MM Short |
|--------------|----------|
| 030607010678 | 010678 |

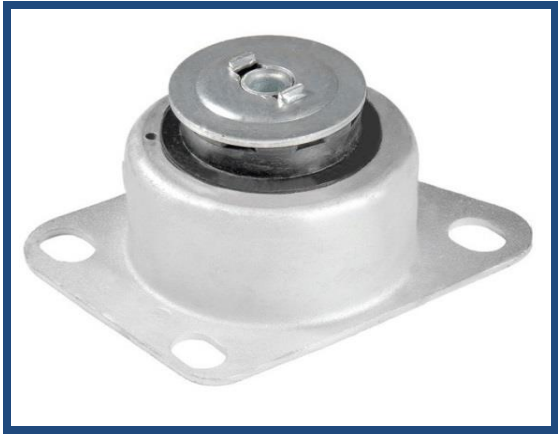

Opis / description

TRANSMISSION MOUNT
 PODUSZKA SILNIKA

Zastosowanie / application

FIAT PALIO; SIENA; ALBEA 1.3 JTD 03.99-06.12-<

O.E.

51718665

| MM Long | MM Short |
|--------------|----------|
| 030607010679 | 010679 |



FIAT

Opis / description

SUSP. BEARING MOUNT
ODBOJNIK AMORTYZATORA

Zastosowanie / application

FIAT PALIO; SIENA 1.2 - 1.4 - 1.6 04.96-03.01->

O.E.

46464298

| MM Long | MM Short |
|--------------|----------|
| 030607010680 | 010680 |

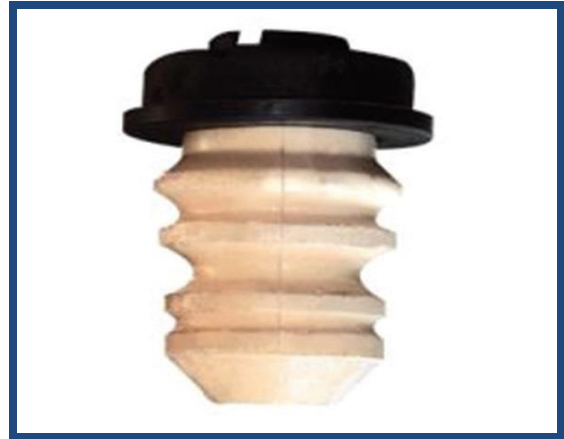

Opis / description

STABILIZER BAR RUB
GUMA STABILIZATORA

Zastosowanie / application

FIAT PALIO, SIENA, ALBEA 2007 POWER STR. 04.96-02.01

O.E.

46465903

| MM Long | MM Short |
|--------------|----------|
| 030607010681 | 010681 |



Opis / description

STABILIZER BAR RUB
GUMA STABILIZATORA

Zastosowanie / application

FIAT PALIO SW 1.2 2002

O.E.

46470776

| MM Long | MM Short |
|--------------|----------|
| 030607010682 | 010682 |



Opis / description

STABILIZER RUBBER
GUMA STABILIZATORA

Zastosowanie / application

FIAT PALIO, SIENA, ALBEA 04.96-03.01-<

O.E.

7520850

| MM Long | MM Short |
|--------------|----------|
| 030607010683 | 010683 |



FIAT

Opis / description

LEAF SPRING BUSHING
TULEJA RESORA

Zastosowanie / application

FIAT DOBLO 1.2 - 1.9 03.01->

O.E.

46767261

| MM Long | MM Short |
|--------------|----------|
| 030607010684 | 010684 |



Opis / description

LEAF SPRING BUSHING
TULEJA RESORA

Zastosowanie / application

FIAT DOBLO 2000 - 2005

O.E.

46766963

| MM Long | MM Short |
|--------------|----------|
| 030607010685 | 010685 |



Opis / description

STABILIZER BAR RUB
GUMA STABILIZATORA

Zastosowanie / application

FIAT DOBLO 2000 - 2005

O.E.

46790552

| MM Long | MM Short |
|--------------|----------|
| 030607010686 | 010686 |



Opis / description

STABILIZER BAR RUB
GUMA STABILIZATORA

Zastosowanie / application

FIAT DOBLO 2000 - 2005

O.E.

46821119

| MM Long | MM Short |
|--------------|----------|
| 030607010687 | 010687 |



FIAT / RENAULT

Opis / description

STABILIZER MOUNTING
TULEJA STABILIZATORA

Zastosowanie / application

FIAT DOBLO 2000

O.E.

7750990

| MM Long | MM Short |
|--------------|----------|
| 030607010688 | 010688 |



Opis / description

SUSP. BEARING MOUNT
ODBOJNIK AMORTYZATORA

Zastosowanie / application

FIAT PALIO, SIENA, ALBEA 1.3 MULTIJET 1997-2009->

O.E.

46464298

| MM Long | MM Short |
|--------------|----------|
| 030607010689 | 010689 |



Opis / description

SUSP. BEARING MOUNT
ODBOJNIK AMORTYZATORA

Zastosowanie / application

FIATSCUDO, ULYSSE; PEUGEOT 806; EXPERT
EVASION; CITROEN JUMPY 06.94-07.02-

O.E.

1307021080

| MM Long | MM Short |
|--------------|----------|
| 030607010690 | 010690 |



Opis / description

STAB. BAR RUBBER
ŁĄCZNIK STABILIZATORA

Zastosowanie / application

RENAULT MEGAN II, CLIO II

O.E.

7700799404

| MM Long | MM Short |
|--------------|----------|
| 030607010691 | 010691 |



RENAULT / OPEL

Opis / description

ENGINE MOUNTING
 PODUSZKA SILNIKA

Zastosowanie / application

RENAULT TRAFIC 2.0 dCi, 2.5 dCi
 OPEL VIVARO 2.0 CDTi, 2.5 Dti

O.E.

8200725253; 4411938; 91167993; 8200049243; 93860700;
 4421191

MM Long

MM Short

030607010692

010692



Opis / description

ENGINE MOUNTING
 PODUSZKA SILNIKA

Zastosowanie / application

RENAULT TRAFIC 1.6;

O.E.

7704000983

MM Long

MM Short

030607010693

010693



Opis / description

ENGINE MOUNTING
 PODUSZKA SILNIKA

Zastosowanie / application

RENAULT TRAFIC II 2.0, 1.9 dCi, 2.0 16V
 OPEL VIVARO 1.9 DI, 1.9 DTi, 2.0 16V,

O.E.

8200003827; 4408746; 91166683

MM Long

MM Short

030607010694

010694



Opis / description

ENGINE MOUNTING
 PODUSZKA SILNIKA

Zastosowanie / application

RENAULT TRAFIC II 1.9 dCi, 2.0 dCi, 2.0
 OPEL VIVARO 1.9 DTi, 2.0 CDTi, 2.0 16V,

O.E.

8200378211; 8200003825; 4418051; 4408760

MM Long

MM Short

030607010695

010695



RENAULT / NISSAN / OPEL

Opis / description

ENGINE MOUNTING
 PODUSZKA SILNIKA

Zastosowanie / application

RENAULT TRAFIC II 2.0 16V, 1.9 dCi, 2.0 16V; OPEL VIVARO 2.0 16V, 1.9 DI, 2.0 ECOTEC, 2.0 16V; NISSAN PRIMASTAR (X83) 2.0, 1.9 dCi

O.E.

8200003824; 4408759; 91166249; 11323-00QAA

MM Long

MM Short

030607010696

010696



Opis / description

ENGINE MOUNTING
 PODUSZKA SILNIKA

Zastosowanie / application

RENAULT TRAFIC II 2.0 16V, 2.0, 2.0 16V; OPEL VIVARO 2.0 16V, 1.9 DI, 2.0 ECOTEC ; NISSAN PRIMASTAR (X83) dCi, 2.0, 1.9 dCi,

O.E.

8200003826; 4408761; 91166684; 11238-00QAA

MM Long

MM Short

030607010697

010697



Opis / description

SUSPENSION STRUT SUPPORT BEARING
 MOCOWANIE AMORTYZATORA

Zastosowanie / application

RENAULT TRAFIC II 2.0 16V, 2.0, 2.0 16V; OPEL VIVARO 2.0 16V, 1.9 DI, 2.0 ECOTEC ; NISSAN PRIMASTAR (X83) dCi, 2.0, 1.9 dCi,

O.E.

8200010493; 4408054; 4420903; 8200904007;
 5432000QAA; 91165309; 93862241

MM Long

MM Short

030607010698

010698



Opis / description

ENGINE MOUNTING
 PODUSZKA SILNIKA

Zastosowanie / application

RENAULT MASTER III 2.3 dCi
 OPEL MOVANO B 2.3 CDTi,

O.E.

8200676857; 4419372; 93197454

MM Long

MM Short

030607010699

010699



RENAULT / OPEL

Opis / description

ENGINE MOUNTING
 PODUSZKA SILNIKA

Zastosowanie / application

RENAULT MASTER II 2.5 dCi, 2.3 dCi
 OPEL MOVANO B 2.3 CDTi

O.E.

112108180R; 93197459; 4419377

| MM Long | MM Short |
|--------------|----------|
| 030607010700 | 010700 |



Opis / description

ENGINE MOUNTING
 PODUSZKA SILNIKA

Zastosowanie / application

RENAULT MASTER III 2.3 dCi
 OPEL - MOVANO B 2.3 CDTi

O.E.

8200675064; 93168597; 4420869

| MM Long | MM Short |
|--------------|----------|
| 030607010701 | 010701 |



Opis / description

ENGINE MOUNTING
 PODUSZKA SILNIKA

Zastosowanie / application

RENAULT MASTER III 2.3 dCi
 OPEL MOVANO B 2.3 CDTi

O.E.

113757025R ; 93168599; 4420871

| MM Long | MM Short |
|--------------|----------|
| 030607010702 | 010702 |



Opis / description

ENGINE MOUNTING
 PODUSZKA SILNIKA

Zastosowanie / application

RENAULT MASTER III 2.3 dCi
 OPEL MOVANO B 2.3 CDTi,

O.E.

8200675206 ; 93197451; 4419368

| MM Long | MM Short |
|--------------|----------|
| 030607010703 | 010703 |



RENAULT / OPEL / NISSAN

Opis / description

ENGINE MOUNTING
 PODUSZKA SILNIKA

Zastosowanie / application

RENAULT MASTER II 3.0 dCi, 2.5 dCi, 1.9 DTi, 2.2 dCi
 OPEL MOVANO 2.5 CDTi, 1.9 DTi, 2.5 DTi, 3.0 Dti, 2.2 Dti

O.E.

8200027176 ; 9110612; 4402612

| MM Long | MM Short |
|---------------------|---------------|
| 030607010704 | 010704 |



Opis / description

ENGINE MOUNTING
 PODUSZKA SILNIKA

Zastosowanie / application

RENAULT MASTER III 2.3 dCi
 OPEL MOVANO B 2.3 CDTi

O.E.

112214498R ; 93168598; 4420870

| MM Long | MM Short |
|---------------------|---------------|
| 030607010705 | 010705 |



Opis / description

SUSPENSION STRUT SUPPORT BEARING
 MOCOWANIE AMORTYZATORA

Zastosowanie / application

RENAULT - MASTER III 2.3 dCi, OPEL MOVANO B 2.3 CDTi,
 NISSAN NV400 2.3 dCi

O.E.

543207065R ; 95507265; 4421359; 54320-00Q0A

| MM Long | MM Short |
|---------------------|---------------|
| 030607010706 | 010706 |



Opis / description

SUSPENSION STRUT SUPPORT BEARING
 MOCOWANIE AMORTYZATORA

Zastosowanie / application

RENAULT ESPACE IV, LAGUNA II, LAGUNA II GRANDTOUR, VEL
 SATIS

O.E.

7700424481

| MM Long | MM Short |
|---------------------|---------------|
| 030607010707 | 010707 |



RENAULT / OPEL

Opis / description

ENGINE MOUNTING
 PODUSZKA SILNIKA

Zastosowanie / application

RENAULT MASTER I (T__), MASTER II (FD), MASTER II (JD); OPEL
 MOVANO (F9) 2.8 DTi, 2.5 D

O.E.

8200022595 ; 7700315382; 4403350; 4500177;
 9160477; 9111350

MM Long

MM Short

030607010708

010708



Opis / description

ENGINE MOUNTING
 PODUSZKA SILNIKA

Zastosowanie / application

RENAULT MASTER I (T__), MASTER II (FD), MASTER II (JD); OPEL
 MOVANO (F9) 2.8 DTi, 2.5 D

O.E.

8200199149 ; 8200304198; 7700308762; 4500183

MM Long

MM Short

030607010709

010709



Opis / description

ENGINE MOUNTING
 PODUSZKA SILNIKA

Zastosowanie / application

RENAULT MASTER I (T__), MASTER II (FD), MASTER II (JD); OPEL
 MOVANO (F9) 2.8 DTi, 2.5 D

O.E.

7700308756 ; 9160480; 4500180

MM Long

MM Short

030607010710

010710



Opis / description

ENGINE MOUNTING
 PODUSZKA SILNIKA

Zastosowanie / application

RENAULT MASTER I (T__), MASTER II (FD), MASTER II (JD);

O.E.

6006000974

MM Long

MM Short

030607010711

010711



RENAULT / DACIA / OPEL

Opis / description

ENGINE MOUNTING
 PODUSZKA SILNIKA

Zastosowanie / application

RENAULT MASTER II 2.2 dCi , 2.5 dCi
 OPEL MOVANO 2.5 DTi, 2.2 Dti

O.E.

8200022596 ; 7700314476; 9111351; 4403351

| MM Long | MM Short |
|--------------|----------|
| 030607010712 | 010712 |



Opis / description

ENGINE MOUNTING
 PODUSZKA SILNIKA

Zastosowanie / application

RENAULT FLUENCE, MEGANE

O.E.

112100019R

| MM Long | MM Short |
|--------------|----------|
| 030607010713 | 010713 |



Opis / description

ENGINE MOUNTING
 PODUSZKA SILNIKA

Zastosowanie / application

RENAULT MEGANE II (BM0/1_/ CM0/1_), SCÉNIC II (JM0/1_)
 DACIA LOGAN (LS_), LOGAN MCV (KS_) SANDERO ; NISSAN APRIO 1.6

O.E.

8200575641 ; 6001549205; 112387053R; 8200014933

| MM Long | MM Short |
|--------------|----------|
| 030607010714 | 010714 |



Opis / description

ENGINE MOUNTING
 PODUSZKA SILNIKA

Zastosowanie / application

RENAULT FLUENCE (L30_) 1.6 Flex, 1.5 dCi ; MEGANE III, SCÉNIC III

O.E.

112205136R ; 112200013R

| MM Long | MM Short |
|--------------|----------|
| 030607010715 | 010715 |



RENAULT / DACIA

Opis / description

ENGINE MOUNTING
 PODUSZKA SILNIKA

Zastosowanie / application

RENAULT MEGANE II (BM0/1_/ CM0/1_), SCÉNIC II (JM0/1_)
 DACIA LOGAN (LS_), LOGAN MCV (KS_) LOGAN EXPRESS (FS_) SANDERO

O.E.

8200500928 ; 8200780781; 6001549647

| MM Long | MM Short |
|--------------|----------|
| 030607010716 | 010716 |



Opis / description

ENGINE MOUNTING
 PODUSZKA SILNIKA

Zastosowanie / application

DACIA LOGAN, DACIA SANDERO

O.E.

113753301R ; 1121000Q1A

| MM Long | MM Short |
|--------------|----------|
| 030607010717 | 010717 |



Opis / description

ENGINE MOUNTING
 PODUSZKA SILNIKA

Zastosowanie / application

RENAULT FLUENCE, GRAND SCENIC III, SCENIC III, MEGANE

O.E.

112105188R

| MM Long | MM Short |
|--------------|----------|
| 030607010718 | 010718 |



Opis / description

ENGINE MOUNTING
 PODUSZKA SILNIKA

Zastosowanie / application

RENAULT FLUENCE, GRAND SCENIC, MEGANE

O.E.

112100014R

| MM Long | MM Short |
|--------------|----------|
| 030607010719 | 010719 |



RENAULT

Opis / description

ENGINE MOUNTING

PODUSZKA SILNIKA

Zastosowanie / application

RENAULT FLUENCE 1.5 dCi, MEGANE III 1.5 dCi, SCÉNIC III 1.2 Tce, 1.4 16V, 1.6 16V, 1.6 E, 2.0 16V, 1.5 dCi, 1.6 dCi, 2.0 dCi

O.E.

112100020R

MM Long

MM Short

030607010720

010720



Opis / description

ENGINE MOUNTING

PODUSZKA SILNIKA

Zastosowanie / application

RENAULT FLUENCE (L30_) 1.6 16V 1.5 dCi, MEGANE III Hatchback (BZ0_) 1.6 16V, MEGANE III (KZ0/1) 1.6 16V, SCÉNIC III (JZ0/1_) 1.6 16V, 1.5 dCi, GRAND SCÉNIC III (JZ0/1_) 1.6 16V 1.5 dCi

O.E.

112380004R

MM Long

MM Short

030607010721

010721



Opis / description

ENGINE MOUNTING

PODUSZKA SILNIKA

Zastosowanie / application

RENAULT MEGANE III 1.5 dCi, 1.4 Tce, MEGANE CC (EZ0/1_) 2.0 CVT, 1.5 dCi, SCÉNIC III 1.5 dCi,

O.E.

112380006R

MM Long

MM Short

030607010722

010722



Opis / description

SUSPENSION STRUT SUPPORT BEARING

MOCOWANIE AMORTYZATORA

Zastosowanie / application

RENAULT MEGANE III (BZ0_) 1.4 Tce, 1.6 16V, 2.0 CVT, 1.5 dCi, 2.0 dCi, MEGANE III (DZ0/1_) 1.4 Tce, 1.6 16V, 2.0 CVT, 2.0 Tce, 1.5 dCi, 1.9 dCi, 2.0 dCi

O.E.

543200001R ; 540340002R

MM Long

MM Short

030607010723

010723



RENAULT

Opis / description

ENGINE MOUNTING

PODUSZKA SILNIKA

Zastosowanie / application

RENAULT MEGANE I 2.0 i, 1.9 DTi, 1.4 e, 2.0 16V, 1.9 DT,
MEGANE SCÉNIC 1.9 DT, 1.9 DTi, 2.0 i,

O.E.

7700832256

| MM Long | MM Short |
|--------------|----------|
| 030607010724 | 010724 |



Opis / description

ENGINE MOUNTING

PODUSZKA SILNIKA

Zastosowanie / application

RENAULT MEGANE I 1.4 e, 1.9 DTi, 2.0 i, 2.0 16V, MEGANE SCÉNIC
1.9 D, 1.9 DTi, 2.0 i, 1.9 DT, SCÉNIC I 1.9 DTi

O.E.

8200277791 ; 7700437391; 7700425757

| MM Long | MM Short |
|--------------|----------|
| 030607010725 | 010725 |



Opis / description

ENGINE MOUNTING

PODUSZKA SILNIKA

Zastosowanie / application

RENAULT MEGANE I 1.9 DTi, 1.9 dCi, MEGANE SCÉNIC 1.9 DTi,
SCÉNIC I (JA0/1) 1.9 DTi, 1.9 dCi, 1.9 dCi R4x4,

O.E.

8200267624 ; 8200185696; 7700436287

| MM Long | MM Short |
|--------------|----------|
| 030607010726 | 010726 |



Opis / description

SUSPENSION STRUT SUPPORT BEARING

MOCOWANIE AMORTYZATORA

Zastosowanie / application

RENAULT MEGANE II 1.4 16V, 1.6 16V, 2.0 16V, RENAULT - MEGANE II (BMO/1_ / CM0/1_) 2.0 16V Turbo, 2.0 Sport,
1.5 dCi, MEGANE II 1.4, 1.6 16V, 2.0, 1.5 dCi, SCÉNIC II 1.4, 1.6 16V, 1.6, 2.0, 2.0 16V Turbo, 1.5 dCi, 1.9 dCi, 1.9 D,
GRAND SCÉNIC II 1.6, 2.0, 1.5 dCi, 1.9 dCi, 2.0 dCi,

O.E.

8200222463

| MM Long | MM Short |
|--------------|----------|
| 030607010727 | 010727 |



RENAULT / DACIA / NISSAN

Opis / description

SUSPENSION STRUT SUPPORT BEARING
MOCOWANIE AMORTYZATORA

Zastosowanie / application

RENAULT MEGANE II (BM0/1_/CM0/1_) 1.4 16V, 1.6, 1.6 16V, 2.0 16V, 2.0, 2.0 16V Turbo

O.E.

8200824774 ; 8200485734; 8200106131; 8200222463

MM Long

030607010728

MM Short

010728



Opis / description

ENGINE MOUNTING
PODUSZKA SILNIKA

Zastosowanie / application

RENAULT CLIO III 1.2 16V, 1.4 16V, 1.6 16V, 1.6 16V GT, 2.0 16V ; DACIA DUSTER 1.6 16V, 1.5 dCi ;
NISSAN ALMERA II Hatchback (N16) 1.5 dCi, NISSAN MICRA III (K12) 1.5 dCi,

O.E.

8200352861 ; 8200168073; 11220-00Q0A

MM Long

030607010729

MM Short

010729



Opis / description

ENGINE MOUNTING
PODUSZKA SILNIKA

Zastosowanie / application

RENAULT MEGANE II 1.5 dCi,
DACIA LOGAN EXPRESS (FS_) 1.5 dCi, LOGAN MCV (KS_) 1.5 dCi

O.E.

8200338372 ; 8200592642; 8200042456

MM Long

030607010730

MM Short

010730



Opis / description

ENGINE MOUNTING
PODUSZKA SILNIKA

Zastosowanie / application

RENAULT MEGANE II 2.0 16V, 2.0 16V Turbo, 1.9 dCi,
SCÉNIC II 2.0, 2.0 16V Turbo

O.E.

8200549046 ; 8200338381; 8200044925; 8200549237

MM Long

030607010731

MM Short

010731



RENAULT / DACIA / NISSAN

Opis / description

ENGINE MOUNTING
 PODUSZKA SILNIKA

Zastosowanie / application

RENAULT MEGANE II 2.0 16V, 1.9 dCi, SCÉNIC II 2.0, 2.0 16V Turbo, 1.9 dCi

O.E.

8200103263 ; 8200272424; 11350BV000

MM Long

030607010732

MM Short

010732



Opis / description

ENGINE MOUNTING
 PODUSZKA SILNIKA

Zastosowanie / application

RENAULT - KANGOO / GRAND KANGOO 1.6, 1.6 16V, 1.5 dCi, LOGAN I 1.4, 1.5 dCi, MEGANE II 1.4 16V, 1.6, 1.6 16V, 2.0 16V, 2.0 16V Turbo, RENAULT SCÉNIC II 1.4, 1.6

O.E.

8200358147 ; 8200297939; 8200014932;
 11220JD000; 11220-00Q0B

MM Long

030607010733

MM Short

010733



Opis / description

SUSPENSION STRUT SUPPORT BEARING
 MOCOWANIE AMORTYZATORA

Zastosowanie / application

RENAULT FLUENCE 1.6 16V, 2.0 16V, 1.5 dCi, LAGUNA III 1.6 16V, 2.0 16V, 2.0 GT, 3.5 V6, 1.5 dCi, LATITUDE 2.0 16V 1.5 dCi, 2.0 dCi, 3.0 dCi, MEGANE III Hatchback (B20_) 1.2 TCe, 1.4 TCe, 1.6 16V, 2.0 CVT, 1.5 dCi, 1.6 dCi, 1.9 dCi SCÉNIC III 1.2 TCe, 1.4 16V, 1.6 16V, 2.0 16V, 1.5 dCi, 1.6 dCi, 1.9 dCi, 2.0 dCi, GRAND SCÉNIC III 1.2 TCe, 1.4 16V, 1.6 16V, 2.0 16V, 1.5 dCi, 1.6 dCi, 1.9 dCi, 2.0 dCi

O.E.

543256557R ; 543251867R; 543250005R

MM Long

030607010734

MM Short

010734



Opis / description

ENGINE MOUNTING
 PODUSZKA SILNIKA

Zastosowanie / application

RENAULT MEGANE III 2.0 TCe, 2.0 TCe, MEGANE III Coupe 2.0 TCe, 2.0 TCe, 2.0 R.S, MEGANE CC 2.0 TCe, 2.0 Turbo

O.E.

113560012R

MM Long

030607010735

MM Short

010735



RENAULT / NISSAN

Opis / description

ENGINE MOUNTING
 PODUSZKA SILNIKA

Zastosowanie / application

RENAULT FLUENCE (L30_) 1.5 dCi, MEGANE III 1.4 TCe, 1.5 dCi, 1.4 TCe, SCÉNIC III 1.4 16V, 1.5 dCi

O.E.

113560009R

| MM Long | MM Short |
|--------------|----------|
| 030607010736 | 010736 |



Opis / description

SUSPENSION STRUT SUPPORT BEARING
 MOCOWANIE AMORTYZATORA

Zastosowanie / application

RENAULT KADJAR, MEGANE IV
 NISSAN QASHQAI

O.E.

543258271R

| MM Long | MM Short |
|--------------|----------|
| 030607010737 | 010737 |



Opis / description

ENGINE MOUNTING
 PODUSZKA SILNIKA

Zastosowanie / application

RENAULT CAPTUR 0.9 TCe, 1.2 TCe, 1.5 dCi, CLIO IV 0.9 TCe, 1.2 16V, 1.6 RS, 1.5 dCi, CLIO IV GranDTour 0.9 TCe, 1.2 16V, 1.5 dCi

O.E.

112383905R ; 112381035R

| MM Long | MM Short |
|--------------|----------|
| 030607010738 | 010738 |



Opis / description

ENGINE MOUNTING
 PODUSZKA SILNIKA

Zastosowanie / application

RENAULT CLIO I 1.2, 1.4, 1.8, 1.8 16V, 1.9 D ; CLIO II 1.2, 1.2 16V, 1.4, 1.4 16V, 1.6, 1.6 16V, 2.0 16V Sport, 3.0 V6 Sport, 1.9 D, 1.9 DTi ; KANGOO 1.2, 1.2 16V, 1.4, 1.6 16V bivalent, 1.6 16V, 1.6 16V 4x4, D 1.9, 1.9 Dti

O.E.

7700434370 ; 7700415096

| MM Long | MM Short |
|--------------|----------|
| 030607010739 | 010739 |



RENAULT

Opis / description

ENGINE MOUNTING

PODUSZKA SILNIKA

Zastosowanie / application

RENAULT CLIO I 1.4, 1.8, 1.8 16V, 2.0 16V Sport, KANGOO 1.6 16V, KANGOO Express 1.6 16V, MEGANE I 2.0 i, 2.0 16V, MEGANE I 1.9 D Eco, 1.9 DT, 1.9 DTi, MEGANE I Classic 2.0 i, 1.9 D, 1.9 DTi, MEGANE SCÉNIC 2.0 i, 1.9 DT, 1.9 DTi, 1.8 16V, 1.9 DTi

O.E.

7700849715 ; 7700314800; 7700805120

MM Long

MM Short

030607010740

010740



Opis / description

ENGINE MOUNTING

PODUSZKA SILNIKA

Zastosowanie / application

RENAULT CLIO II 1.2, 1.2 16V, 1.4, 1.4 16V, 1.6, 1.5 dCi, 1.9 D, 1.9 DTi, MEGANE I 1.4 16V, 1.6 16V, 1.9 D Eco, 1.4 16V, MEGANE I Classic 1.6 16V, 1.9 D, MEGANE SCÉNIC 1.4 i, 1.6 i, SYMBOL I 1.2 16V, 1.4, 1.4 16V, 1.5 dCi

O.E.

8200171178 ; 8200117837; 7700437854

MM Long

MM Short

030607010741

010741



Opis / description

ENGINE MOUNTING

PODUSZKA SILNIKA

Zastosowanie / application

RENAULT CLIO I 1.1, 1.2, 1.4, 1.8, 1.8 Rsi, 1.8 16V, 1.9 D, EXPRESS BOX 1.4 Cat, 1.4, 1.9 D

O.E.

7700806577 ; 7700795689

MM Long

MM Short

030607010742

010742



Opis / description

SUSPENSION STRUT SUPPORT BEARING

MOCOWANIE AMORTYZATORA

Zastosowanie / application

RENAULT CLIO II 1.2, 1.2 16V, 1.4, 1.4 16V, 1.6, 1.6 16V, 3.0 V6 Sport, 1.5 dCi, 1.9 D, 1.9 DT, KANGOO 1.2, 1.2 16V, 1.4, 1.6 16V, 1.6 16V 4x4, D 1.9, 1.9 DTi, KANGOO Express 1.2, 1.4, D 1.9, 1.9 DTi, TWINGO II 1.2, 1.2 16V, 1.5 dCi

O.E.

7700829529 ; 8200053795

MM Long

MM Short

030607010743

010743



RENAULT / NISSAN

Opis / description

SUSPENSION STRUT SUPPORT BEARING

MOCOWANIE AMORTYZATORA

Zastosowanie / application

RENAULT CAPTUR, MEGAN IV

NISSAN QASHQAI II 1.2 DIG_T, 1.6 DIG_T, 1.5 dCi, 1.6 dCi

O.E.

543206968R ; 543258271R

MM Long

MM Short

030607010744

010744



Opis / description

ENGINE MOUNTING

PODUSZKA SILNIKA

Zastosowanie / application

RENAULT CLIO II 1.2, 1.2 LP,

KANGOO Express 1.2

O.E.

8200175102

MM Long

MM Short

030607010745

010745



Opis / description

ENGINE MOUNTING

PODUSZKA SILNIKA

Zastosowanie / application

RENAULT KANGOO 1.9 dCi 4x4, 1.6 16V, 1.9 DTi, 1.9 dCi 4x4, 1.9 dCi ; MEGANE I 1.8 16V, 1.9 D Eco, 1.9 DTi, 1.9 dCi ; MEGANE I Classic 1.8 16V, 1.9 DTi, 1.9 dCi ; MEGANE I GrandTour 1.8 16V, 1.9 DTi, 1.9 dCi ; MEGANE I Coach 2.0 i, 1.9 DTi, 1.9 dCi ; MEGANE SCENIC 1.6 16V, 1.9 DTi ; SCENIC I 1.4 16V, 1.8 16V, 2.0 16V, 1.9 DTi, 1.9 dCi, 1.9 dCi R4x4

O.E.

8200148388 ; 8200100116; 7700432031; 8200493821

MM Long

MM Short

030607010746

010746



Opis / description

ENGINE MOUNTING

PODUSZKA SILNIKA

Zastosowanie / application

RENAULT CLIO II 1.5 dCi, 1.9 DTi, 1.5 dCi ; KANGOO 1.5 dCi, 1.9 dCi

4x4 ; KANGOO Express 1.5 dCi, 1.9 DTi, 1.9 dCi 4x4

O.E.

8200267625 ; 8200170361; 8200170362;

8200220400; 7700436286

MM Long

MM Short

030607010747

010747



RENAULT

Opis / description

ENGINE MOUNTING
 PODUSZKA SILNIKA

Zastosowanie / application

RENAULT CLIO II 1.9 D ; KANGOO D 1.9 ; KANGOO Express
 D 1.9

O.E.

7700415095 ; 7700428936

| MM Long | MM Short |
|--------------|----------|
| 030607010748 | 010748 |



Opis / description

SUSPENSION STRUT SUPPORT BEARING
 MOCOWANIE AMORTYZATORA

Zastosowanie / application

RENAULT CLIO I 1.1, 1.2, 1.4, 1.8 Rsi, 1.9 D ;
 TWINGO I 1.2, 1.2 16V

O.E.

7700827435

| MM Long | MM Short |
|--------------|----------|
| 030607010749 | 010749 |



Opis / description

ENGINE MOUNTING
 PODUSZKA SILNIKA

Zastosowanie / application

RENAULT CLIO II 1.5 dCi, CLIO II BUX 1.5 dCi ; KANGOO 1.6 16V, 1.6 16V 4x4, 1.9 DTI ; KANGOO
 Express 1.6 16V bivalent, 1.6 16V, 1.6 16V 4x4, 1.9 DTI ; GRAND KANGOO 1.6, 1.6 16V ; KANGOO
 Express 1.6 16V ; MEGANE I 1.4 Eco, 1.9 DT, 1.9 Tdi

O.E.

7700832264 ; 7700315024

| MM Long | MM Short |
|--------------|----------|
| 030607010750 | 010750 |



Opis / description

ENGINE MOUNTING
 PODUSZKA SILNIKA

Zastosowanie / application

RENAULT CLIO II 1.2 16V, 1.4 16V, 1.6 16V, 1.5 dCi, 1.5 dCi ; KANGOO 1.6 16V bivalent, 1.6 16V, 1.6
 16V 4x4, 1.5 dCi, 1.6 16V, 1.6 16V 4x4, KANGOO Express 1.5 dCi, 1.9 DTI ; MEGANE II 1.5 dCi ;
 TWINGO II 1.2, 1.2 16V, 1.6 RS, RENAULT - TWINGO II (CNO_) 1.5 dCi

O.E.

8200151995

| MM Long | MM Short |
|--------------|----------|
| 030607010751 | 010751 |



RENAULT / DACIA / NISSAN

Opis / description

SUSPENSION STRUT SUPPORT BEARING

MOCOWANIE AMORTYZATORA

Zastosowanie / application

DACIA LOGAN 1.4,1.6, 1.6 16V, 1.5 dCi ,LOGAN MCV 1.4, 1.6, 1.6 16V, 1.5 dCi ;
LOGAN EXPRESS 1.4, 1.6, 1.5 dCi ; SANDERO 1.4, 1.6, 1.5 dCi

O.E.

6001025850 ; 7700800107; 5432500QAA; 8200651172

MM Long

030607010752

MM Short

010752



Opis / description

ENGINE MOUNTING

PODUSZKA SILNIKA

Zastosowanie / application

RENAULT CLIO III 1.5 dCi ; MEGANE II 1.5 dCi ; MODUS / GRAND MODUS (F/JP0_) 1.2 , 1.4, 1.5 dCi,
1.6 ; SCÉNIC II (JM0/1_) 1.5 dCi ; NISSAN - MICRA III (K12) 1.2 16V, NISSAN MICRA III 1.4 16V, 1.5 dCi
; NOTE 1.4, 1.6, 1.5 dCi

O.E.

8200338385 ; 8200399188; 8200042453

MM Long

030607010753

MM Short

010753



Opis / description

ENGINE MOUNTING

PODUSZKA SILNIKA

Zastosowanie / application

RENAULT CLIO III 1.2 16V, 1.4 16V, 1.6 16V, 1.6 16V G1, 1.5 dCi ; CLIO GrandTour 1.4 16V, 1.6 16V,
1.5 dCi ; MODUS / GRAND MODUS 1.2 16V, 1.4, 1.6, 1.5 dCi ; NISSAN MICRA III 1.4 16V, 1.5 dCi ;
NOTE 1.4, 1.6, 1.5 dCi

O.E.

8200140431

MM Long

030607010754

MM Short

010754



Opis / description

SUSPENSION STRUT SUPPORT BEARING

MOCOWANIE AMORTYZATORA

Zastosowanie / application

NISSAN MICRA III 1.0 16V, 1.2 16V, 1.4 16V SR, 1.5 dCi ; MICRA C+C III 1.4 16V, 1.6 SR ; RENAULT CLIO III 1.2 16V, 1.2 16V HiFlex, 1.4 16V, 1.6 16V, 1.6
16V GT, 2.0 16V, 2.0 16V Sport, 1.5 dCi ; CLIO GrandTour (KR0/1_) 1.2 16V, 1.2 16V HiFlex, 1.2 16V, 1.4 16V, 1.2 16V, 1.6 16V, 1.5 dCi ; MODUS / GRAND
MODUS 1.2, 1.2 16V HiFlex, 1.2, 1.2 16V, 1.2, 1.4, 1.6, 1.5 dCi

O.E.

8200504295 ; 7701208591; 54320-AX600; 7701208823;

8200183568; 54320BC40A

MM Long

030607010755

MM Short

010755



RENAULT / NISSAN / MERCEDES BENZ

Opis / description

SUSPENSION STRUT SUPPORT BEARING

MOCOWANIE AMORTYZATORA

Zastosowanie / application

NISSAN MICRA III 1.0 16V, 1.2 16V, 1.4 16V, SR, 1.5 dCi; MICRA C+C III 1.4 16V, 1.6 SR; RENAULT CLIO III 1.2 16V, 1.2 16V HiFlex, 1.4 16V, 1.6 16V, 1.6 16V GT, 2.0 16V, 2.0 16V Sport, 1.5 dCi; CLIO GrandTour 1.2 16V, 1.4 16V, 1.2 16V, 1.6 16V, 1.5 dCi; MODUS / GRAND MODUS 1.2, 1.2 16V HiFlex, 1.2, 1.2 16V, 1.4, 1.6, 1.5 dCi

O.E.

8200504291 ; 54321-AX600; 8200183567

MM Long

MM Short

030607010756

010756



Opis / description

SUSPENSION STRUT SUPPORT BEARING

MOCOWANIE AMORTYZATORA

Zastosowanie / application

MERCEDES BENZ - CITAN (415) CDI; NISSAN - CUBE (Z12) 1.6 16V, NISSAN CUBE 1.5 dCi, JUKE (F15), MICRA III (K12); MICRA C+C III (K12); NOTE (E11/NE11); PULSAR, QASHQAI / QASHQAI +2 (J10/J10); TIIDA Saloon (SC11); X-TRAIL (T30); NV200 / EVALIA; RENAULT CLIO III (BR0/1/CR0/1); CLIO GrandTour (KR0/1); KANGOO / GRAND KANGOO (KW0/1); KANGOO Express (FW0/1); KOLEOS (HY)

O.E.

8200948647 ; 8200200017; 4153220184; 543251KA0A;
543250375R; 54325JE20B; 54325ED00A; 543253RA0A

MM Long

MM Short

030607010757

010757



Opis / description

ENGINE MOUNTING

PODUSZKA SILNIKA

Zastosowanie / application

RENAULT CLIO III 1.5 dCi; CLIO GrandTour 1.5 dCi, MODUS / GRAND MODUS 1.5 dCi

O.E.

112104344R

MM Long

MM Short

030607010758

010758



Opis / description

SUSPENSION STRUT SUPPORT BEARING

MOCOWANIE AMORTYZATORA

Zastosowanie / application

RENAULT CAPTUR 0.9 Tce, 1.2 T, 1.2 Tce, 1.5 dCi; CLIO III 1.2 16V HiFlex, 1.2 16V, 1.2, 1.4 16V, 1.6 16V, 1.6 16V GT, 2.0 16V, 1.5 dCi; CLIO GrandTour 1.2 16V, 1.2 16V HiFlex, 1.4 16V, 1.5 dCi; CLIO IV 0.9 Tce, 1.2 16V, 1.2 Tce, 1.6 RS, 1.5 dCi; CLIO IV GrandTour 0.9 Tce, 1.2 16V, 1.2 Tce, 1.5 dCi; CLIO IV 0.9 Tce, 1.5 dCi, MODUS / GRAND MODUS 1.2 16V HiFlex, 1.2, 1.2 16V, 1.4, 1.6, 1.5 dCi, ZOE

O.E.

543024644R

MM Long

MM Short

030607010759

010759



RENAULT

Opis / description

SUSPENSION STRUT SUPPORT BEARING
MOCOWANIE AMORTYZATORA

Zastosowanie / application

RENAULT CLIO I Electric, 1.4, 1.7, 1.8, 1.8 Rsi, 1.8 16V, Williams, 1.9 D,

O.E.

7700827436 ; 7700797578; 7700794802

MM Long

MM Short

030607010760

010760



Opis / description

SUSPENSION STRUT SUPPORT BEARING
MOCOWANIE AMORTYZATORA

Zastosowanie / application

RENAULT CLIO I (B/C57_/5/357_); CLIO II (BB0/1/2_/CB0/1/2_); KANGOO (KCO/1_); KANGOO Express (FC0/1_); SYMBOL I (LB0/1/2_); SYMBOL II (LU1/2_) TWINGO I (CO6_)

O.E.

7700426450 ; 7700798900; 7700828866; 7700820501

MM Long

MM Short

030607010761

010761



Opis / description

SUSPENSION STRUT SUPPORT BEARING
MOCOWANIE AMORTYZATORA

Zastosowanie / application

RENAULT CAPTUR 0.9 TCe, 1.2 TCe, 1.5 dCi ; CLIO III (BR0/1/ CR0/1) ; CLIO GrandTour (KR0/1_); CLIO IV (BH_); CLIO IV GrandTour (KH_); MODUS / GRAND MODUS (F/JPO_)

O.E.

543259539R

MM Long

MM Short

030607010762

010762



Opis / description

ENGINE MOUNTING
PODUSZKA SILNIKA

Zastosowanie / application

RENAULT CLIO IV

O.E.

113755975R

MM Long

MM Short

030607010763

010763



RENAULT / MERCEDES BENZ

Opis / description

SUSPENSION STRUT SUPPORT BEARING

MOCOWANIE AMORTYZATORA

Zastosowanie / application

MERCEDES BENZ CITAN (415) CDI; RENAULT KANGOO Express 1.6 Flex, KANGOO / GRAND KANGOO 1.6, 1.6 16V, 1.5 dCi; KANGOO Express 1.6, 1.6 16V LPG, 1.5 dCi, KANGOO BE BOP 1.6, 1.5 dCi

O.E.

8200591283 ; 4153230020; A4153230020

MM Long

MM Short

030607010764

010764



Opis / description

ENGINE MOUNTING

PODUSZKA SILNIKA

Zastosowanie / application

RENAULT KANGOO / GRAND KANGOO 1.6, 1.6 16V, 1.6 16V HiFlex, 1.5 dCi; KANGOO Express 1.6, 1.6 16V, 1.5 dCi, KANGOO BE BOP 1.6

O.E.

8200427530

MM Long

MM Short

030607010765

010765



Opis / description

ENGINE MOUNTING

PODUSZKA SILNIKA

Zastosowanie / application

RENAULT KANGOO (KC0/1_) 1.5 dCi, GRAND KANGOO (KW0/1_) 1.5 dCi, KANGOO Express (FW0/1_) 1.5 dCi

O.E.

8200423501

MM Long

MM Short

030607010766

010766



Opis / description

ENGINE MOUNTING

PODUSZKA SILNIKA

Zastosowanie / application

RENAULT KANGOO / GRAND KANGOO (KW0/1_) 1.5 dCi, 1.5 dCi; KANGOO Express (FW0/1_) 1.5 dCi; KANGOO BE BOP (KW0/1_) 1.5 dCi,

O.E.

8200427529

MM Long

MM Short

030607010767

010767



RENAULT

Opis / description

ENGINE MOUNTING
 PODUSZKA SILNIKA

Zastosowanie / application

O.E.

8200355673

| MM Long | MM Short |
|--------------|----------|
| 030607010768 | 010768 |



Opis / description

ENGINE MOUNTING
 PODUSZKA SILNIKA

Zastosowanie / application

O.E.

112102294R ; 8200674936

| MM Long | MM Short |
|--------------|----------|
| 030607010769 | 010769 |



Opis / description

SUSPENSION STRUT SUPPORT BEARING
 MOCOWANIE AMORTYZATORA

Zastosowanie / application

O.E.

7700835254 ; 7700780875

| MM Long | MM Short |
|--------------|----------|
| 030607010770 | 010770 |



Opis / description

ENGINE MOUNTING
 PODUSZKA SILNIKA

Zastosowanie / application

O.E.

7700785949 ; 7700796085

| MM Long | MM Short |
|--------------|----------|
| 030607010771 | 010771 |



RENAULT

Opis / description

ENGINE MOUNTING
 PODUSZKA SILNIKA

Zastosowanie / application

O.E.

7700801543 ; 7700794601

| MM Long | MM Short |
|--------------|----------|
| 030607010772 | 010772 |



Opis / description

ENGINE MOUNTING
 PODUSZKA SILNIKA

Zastosowanie / application

O.E.

7700804163 ; 7700805733; 7700785950

| MM Long | MM Short |
|--------------|----------|
| 030607010773 | 010773 |



Opis / description

ENGINE MOUNTING
 PODUSZKA SILNIKA

Zastosowanie / application

O.E.

7700800522 ; 7700424321; 7700841151

| MM Long | MM Short |
|--------------|----------|
| 030607010774 | 010774 |



Opis / description

ENGINE MOUNTING
 PODUSZKA SILNIKA

Zastosowanie / application

O.E.

8200089697 ; 7700788318

| MM Long | MM Short |
|--------------|----------|
| 030607010775 | 010775 |



RENAULT

Opis / description

ENGINE MOUNTING
 PODUSZKA SILNIKA

Zastosowanie / application

O.E.

7700427286

| MM Long | MM Short |
|--------------|----------|
| 030607010776 | 010776 |



Opis / description

SUSPENSION STRUT SUPPORT BEARING
 MOCOWANIE AMORTYZATORA

Zastosowanie / application

O.E.

7700716824

| MM Long | MM Short |
|--------------|----------|
| 030607010777 | 010777 |



Opis / description

ENGINE MOUNTING
 PODUSZKA SILNIKA

Zastosowanie / application

O.E.

7700411189

| MM Long | MM Short |
|--------------|----------|
| 030607010778 | 010778 |



Opis / description

ENGINE MOUNTING
 PODUSZKA SILNIKA

Zastosowanie / application

O.E.

8200000002

| MM Long | MM Short |
|--------------|----------|
| 030607010779 | 010779 |



RENAULT

Opis / description

ENGINE MOUNTING
 PODUSZKA SILNIKA

Zastosowanie / application

O.E.

112380015R

| MM Long | MM Short |
|--------------|----------|
| 030607010780 | 010780 |



Opis / description

ENGINE MOUNTING
 PODUSZKA SILNIKA

Zastosowanie / application

O.E.

8200038864 ; 8200302003; 8200367493; 8200125490;
 8200125534

| MM Long | MM Short |
|--------------|----------|
| 030607010781 | 010781 |



Opis / description

SUSPENSION STRUT SUPPORT BEARING
 MOCOWANIE AMORTYZATORA

Zastosowanie / application

O.E.

7700777654; 7700824022; 7700803635; 7700760571;
 7700824022

| MM Long | MM Short |
|--------------|----------|
| 030607010782 | 010782 |



Opis / description

ENGINE MOUNTING
 PODUSZKA SILNIKA

Zastosowanie / application

O.E.

8200805809; 112106262R; 112103095R; 112100627R

| MM Long | MM Short |
|--------------|----------|
| 030607010783 | 010783 |



RENAULT

Opis / description

ENGINE MOUNTING
 PODUSZKA SILNIKA

Zastosowanie / application

O.E.

112103095R; 112845638R; 113758078R

| MM Long | MM Short |
|---------------------|---------------|
| 030607010784 | 010784 |



Opis / description

ENGINE MOUNTING
 PODUSZKA SILNIKA

Zastosowanie / application

O.E.

112205217R

| MM Long | MM Short |
|---------------------|---------------|
| 030607010785 | 010785 |



Opis / description

SUSPENSION STRUT SUPPORT BEARING
 MOCOWANIE AMORTYZATORA

Zastosowanie / application

O.E.

6001547499; 8200275528

| MM Long | MM Short |
|---------------------|---------------|
| 030607010786 | 010786 |



Opis / description

ENGINE MOUNTING
 PODUSZKA SILNIKA

Zastosowanie / application

O.E.

6001547893; 6001548157; 8200420742; 8200805581;
 112107695R

| MM Long | MM Short |
|---------------------|---------------|
| 030607010787 | 010787 |



RENAULT

Opis / description

ENGINE MOUNTING
 PODUSZKA SILNIKA

Zastosowanie / application

O.E.

6001549202; 8200674936

| MM Long | MM Short |
|---------------------|---------------|
| 030607010788 | 010788 |



Opis / description

ENGINE MOUNTING
 PODUSZKA SILNIKA

Zastosowanie / application

O.E.

112383665R; 8200780781

| MM Long | MM Short |
|---------------------|---------------|
| 030607010789 | 010789 |



Opis / description

ENGINE MOUNTING
 PODUSZKA SILNIKA

Zastosowanie / application

O.E.

8200805805; 112101351R

| MM Long | MM Short |
|---------------------|---------------|
| 030607010790 | 010790 |



Opis / description

ENGINE MOUNTING
 PODUSZKA SILNIKA

Zastosowanie / application

O.E.

112108607R

| MM Long | MM Short |
|---------------------|---------------|
| 030607010791 | 010791 |

